





**SPEKIFIKASI PERKHIDMATAN MEMBEKAL PERALATAN SIARAYA UNTUK KEGUNAAN BAHAGIAN DAKWAH
JABATAN AGAMA ISLAM SELANGOR**

BIL	PERALATAN	SPESIFIKASI	GAMBAR
1.	<p>Digital Mixing Console With Case</p> <p>Model SOUNDCRAFT</p> <p>Brand SI PER 3</p>	<p>24 (32 - Si Performer 3) mono mic inputs 8 line inputs 80 channels to mix possible LCR panning Pre/Post selection per input per bus Soundcraft FaderGlow™ GEQ on every bus 20 sub-group / aux busses 4 FX busses 8 Matrix busses LRC Mix busses 5 Stereo Lexicon Effects engines Delay on inputs and outputs 8 Mute Groups 8 VCA Groups AES in and out Colour backlit LCD screens per fader DMX interface Freely assignable insert loops Harman HiQnet integration Dual option card slots Colour touch screen interface</p>	

BIL	PERALATAN	SPESIFIKASI	GAMBAR
2.	<p>Monitor Speaker 12"</p> <p>Model ZOMAX</p> <p>Brand DP 12</p>	<p>System Type: 2-Way 12" Full Range Frequency Response: 50hz-18khz Dispersion: H80°xV50° Handling Power: 300w(Rms)/600w(Peak) Sensitivity: 97db Maximum Spl : 125db Impedance: 8 Ohms Suspension: Yes Dimensions(W*D*H): 388x370x618(Mm) Net Weight: 25kg</p>	
3.	<p>Wireless Microphone</p> <p>Model SHURE</p> <p>Brand SLX24SM58</p>	<p>Automatic Transmitter Setup Backlit LCD with timeout feature Frequency and power lockout 3-segment battery fuel gauge 2 AA batteries (included) provide 8 hours of continuous use 470 - 782 MHz operating range Interchangeable cartridges: Beta 87A, Beta87C, Beta 58A, SM86, and the legendary SM58. Interchangeable cartridges: Beta 87A, Beta87C, Beta 58A, SM86, and the legendary SM58.</p>	



BIL	PERALATAN	SPESIFIKASI	GAMBAR
4.	<p>Walkie Talkie</p> <p>Model MOTOROLA</p> <p>Brand GP 638 PLUS</p>	<p>Supports MDC1200 signalling, Quick Call signaling and DTMF signaling</p> <p>Equipped with LCD display, users will be warned on low battery strength through the LDC indicator</p> <p>Easy to read 14-character alphanumeric dot matrix text display enable user to identify the caller and radio's operating status at a glance</p> <p>Name tagging with capability to assign 8 different visual caller-ID to 8 specific users/talkgroups</p> <p>Easy to navigate menu keys allow users to select the relevant functionalities at their fingertips</p> <p>Dual Tone Multiple Frequency (DTMF) Encode allows user easy</p> <p>Access to local telephone networks or to make a private calls to other radio system users from one radio</p>	

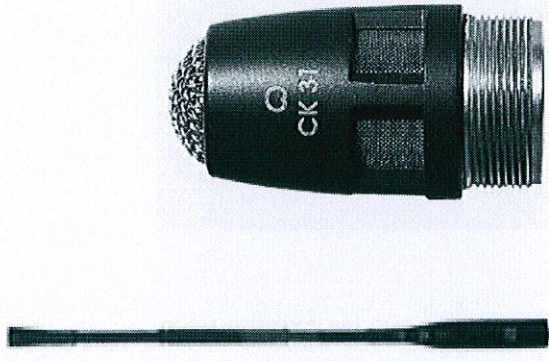

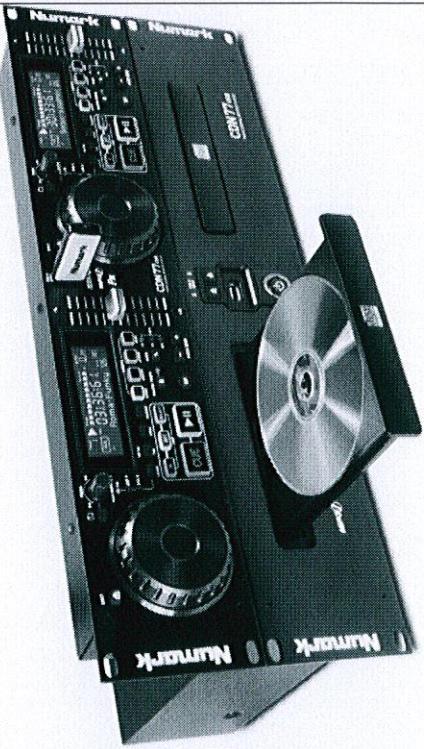
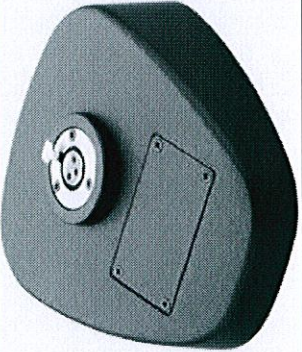
BIL	PERALATAN	SPESIFIKASI	GAMBAR
5.	<p>Sound Analyzer Meter</p> <p>Model PHONIC</p> <p>Brand PAA3</p>	<p>Handheld Audio Analyzer with USB Interface Built-in calibrated measurement microphone 1/3 octave real-time analyzer 31-band EQ setting value display (boost/cut) RT60 measurement Phase checker Noise generator with pink noise, 1kHz and polarity test signal, balanced output Memory and average calculation function SPL meter calibration through sound level calibrator Sound Pressure Level Meter from 30 dB~130 dB Line signal measurement display in dBu, dBV, or Volts (AC) SPL meter and level meter have three level range selections Maximum level, Peak hold displays XLR input and output sockets USB interface for desktop software control Audio test signal CD and supporting software Three power modes: (1) Power Save (2) On (3) Off Operates seven hours with four AA batteries AC power adapter included</p>	

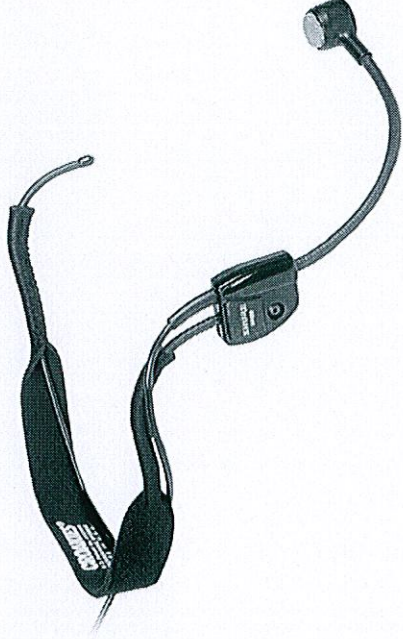
BIL	PERALATAN	SPESIFIKASI	GAMBAR
6.	<p>Goosenek Microphone + Capsule Microphone</p> <p>Model AKG</p> <p>Brand GN 30+CK 31</p>	<p>The GN30 and GN50 are gooseneck modules for permanent screw-on installations, for use with all Discreet Acoustics modular capsules these goosenecks feature rugged construction, highly reliable contacts for capsule modules integrated LED ring status indicator; and integrated, jumper-selectable bass rolloff</p> <p>The GN30 is approx. 12 in, goosenecks come with a DPA in-line XLR phantom power adapter with integrated 250 Hz bass rolloff and LED ON/OFF jumper</p> <p>The DPA connects to any XLR mixer input with 9 to 52 V phantom power</p> <p>The mini XLR connector on the DPA cable will thread through any hole only 11 mm (0.44 in.) in diameter or larger</p> <p>This eliminates the need for large holes or awkward unsoldering and resoldering of the much larger phantom power adaptor during installation.</p> <p>Use with any of the AKG Discreet Acoustics mic modules: CK31 - cardioid</p>	

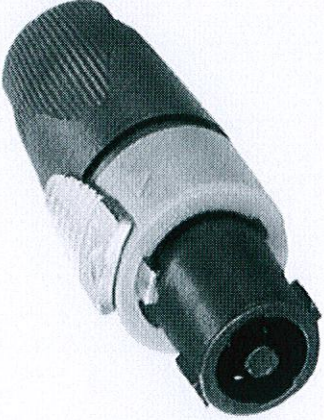
BIL	PERALATAN	SPESIFIKASI	GAMBAR
7.	<p>Mp3 Double CD Player</p> <p>Model NUMARK</p> <p>Brand CDN77USB</p>	<p>CDN77USB is a Dual USB and MP3 CD player designed for professional DJs USB drive support allows you to put your entire digital music library on a USB flash or hard drive and use it at a gig If you're a DJ transitioning to using MP3 files, CDN77USB is ideal for you because it allows you to still use your entire library of CDs or MP3 CDs In addition, CDN77USB comes loaded with features like Master Tempo, Scratching, Seamless Loop, Pitch Control Reverse and Brake effects and an Auto-BPM counter, making CDN77USB an affordably priced unit with premium features. For DJs whose libraries live on their computer, CDN77USB is a perfect solution Thousands of songs can be loaded from a computer onto a, USB flash or hard drive, which can then be accessed from either of the CDN77USB</p>	
8.	<p>Gooseneck Microphone Table Base</p> <p>Model KONIG & MEYER</p> <p>Brand 29390</p>	<p>Material: zinc die-cast 3-pin XLR socket 3-pin XLR connector Dimensions: 16 x 15 x 5.1 cm Weight: 2.44 kg Colour: black</p>	

BIL	PERALATAN	SPESIFIKASI	GAMBAR
9.	<p>Wire Microphone</p> <p>Model SHURE</p> <p>Brand SM58</p>	<p>Frequency response tailored for vocals, with brightened midrange and bass rolloff</p> <p>Uniform cardioid pickup pattern isolates the main sound source and minimizes background noise</p> <p>Pneumatic shock-mount system cuts down handling noise</p> <p>Effective, built-in spherical wind and pop filter</p> <p>Supplied with break-resistant stand adapter which rotates 180 degrees</p> <p>Legendary Shure quality, ruggedness and reliability</p> <p>Cardioid (unidirectional) dynamic</p> <p>Frequency response: 50 to 15,000 Hz</p> <p>Replacement cartridge: R59</p>	
10.	<p>Headworn Microphone & Transmitter Set</p> <p>Model SHURE</p> <p>Brand WH20TQG</p>	<p>Lightweight wireframe and headband adjust for a secure, comfortable fit.</p> <p>Extra-strong, small-diameter attached microphone cable resists breakage.</p> <p>Collapsible microphone boom for easy storage and transportation.</p> <p>Smooth, natural frequency response comparable to high-quality dynamic hand-held vocal microphones.</p> <p>High input clipping level eliminates overload distortion.</p> <p>Reliable at temperature and humidity extremes.</p>	

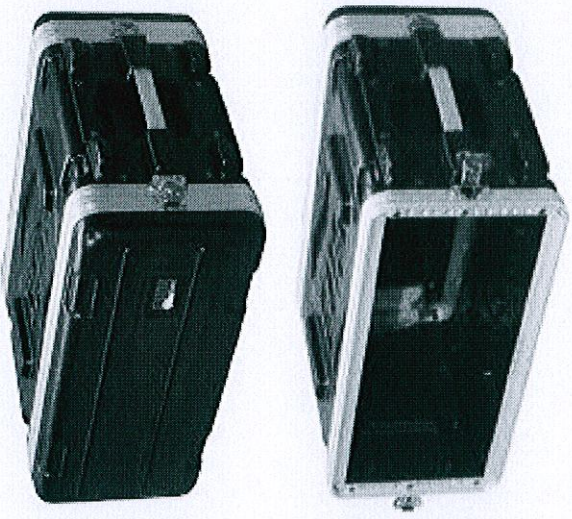
BIL	PERALATAN	SPESIFIKASI	GAMBAR
11.	<p>Speakon</p> <p>Model NEUTRIK</p> <p>Brand 2NL</p>	<p>Type – NL 2 FC</p> <p>Cable connection diameter - 6 - 10 mm</p> <p>RoHS compliant – yes</p> <p>Plug construction - Plug, Cable Mount</p> <p>Content - 1 Units</p> <p>Number of pins - 2</p> <p>Manufacturer part no. – NL 2 FC</p> <p>Specification - Straight plug</p> <p>temperature range - 30 - +80 °C</p> <p>Connection - Soldering/screw bolting</p>	
12.	<p>Speaker Extension</p> <p>Model NEUTRIK</p> <p>Brand 4NL</p>	<p>Type – NL 4 FX</p> <p>Cable connection diameter - 6 - 14 mm</p> <p>RoHS compliant – yes</p> <p>Plug construction - Plug, Cable Mount</p> <p>Content - 1 Units</p> <p>Number of pins - 4</p> <p>Manufacturer part no. – NL 4 FX</p> <p>Specification - Straight plug</p> <p>temperature range - 30 - +80 °C</p> <p>Connection - Soldering/screw bolting</p>	

BIL	PERALATAN	SPESIFIKASI	GAMBAR
13.	<p>Wireless Microphone Rack 4U</p> <p>Model GATOR</p> <p>Brand GR-4S</p>	<p>4 Rack Spaces Front Rail to Back Rail: 12" Total Rackable Space: 14 1/4" Lid Depth: 2 1/4" Exterior: 10" x 22" x 14 1/2" Ext Construction/Materials Lightweight Polyethylene External Depth 17.5" External Height 9.5" External Width 21.5" Int Depth Front Rack to Back Lid 14.75" Int Depth Lid to Lid 17.25" Lid Depth 2.5" Rack Spaces Total 4U Shockmount No Weight 11 lbs. Manufacturer Part Number GR-4S</p>	
14.	<p>Effect Rack 6U</p> <p>Model GATOR</p> <p>Brand GR-6S</p>	<p>6 Rack Spaces Front Rail to Back Rail: 12" Total Rackable Space: 14 1/4" Lid Depth: 2 1/4" Total Rackable Space: 14 1/4" Exterior: 13 1/2" x 22" x 14 1/2" Ext Construction/Materials Polyethylene External Depth 17.5" External Height 13" External Width 21.5" Int Depth Front Rack to Back Lid 14.75"</p>	

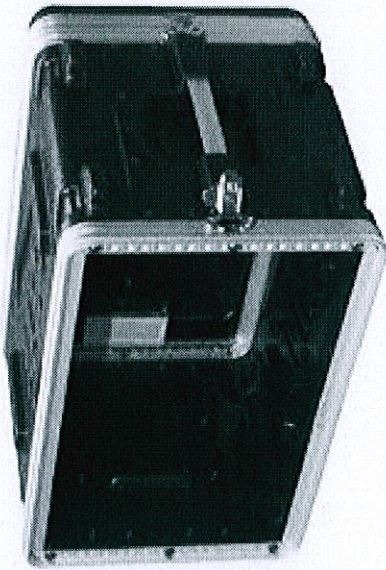
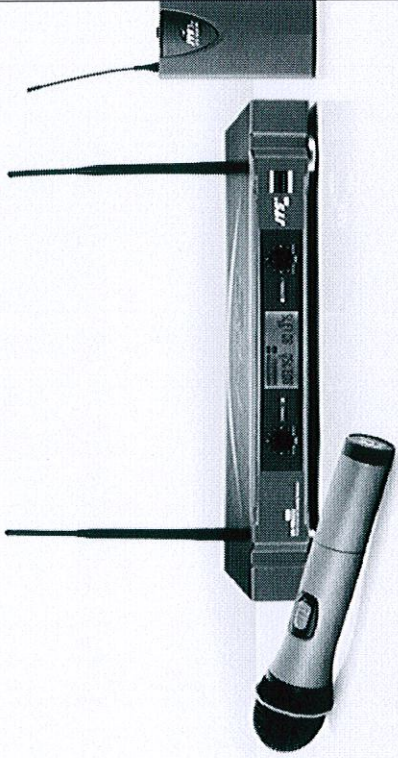
BIL	PERALATAN	SPESIFIKASI	GAMBAR
		<p>Int Depth Lid to Lid 17.25" Lid Depth 2.5" Rack Spaces Total 6U Shockmount No Weight 13lbs. Manufacturer Part Number GR-6S</p>	
15	<p>Dual Wireless Microphone Model JTS Brand US-9020D PRO MH-8000</p>	<p>US-9020D Pro Dual transmitter operation. Diversity technology prevents dropouts in the RF link. Noise mute and pilot tone squelch. Adjustable squelch level. LCD display with frequency, mute, RF and AF levels. Equipped with both XLR balanced and Ø6.3mm unbalanced. Mh-8000i Operation in the UHF range. Extended dynamic range and smooth frequency response. Advanced circuit design for excellent sound quality.</p>	

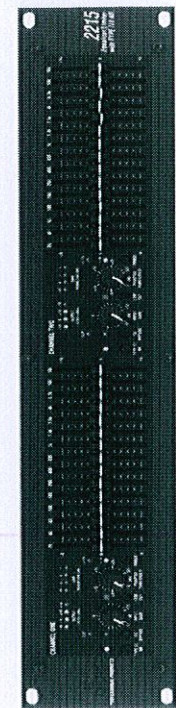
BIL	PERALATAN	SPESIFIKASI	GAMBAR
		<p>Interchangeable capsule module design for convenient replacement. Internal antenna design. Available in condenser or dynamic capsule. LED display for power and low battery.s</p>	
16.	<p>Graphic Equalizer Model DBX Brand 2215</p>	<p>Connectors: 1/4" TRS, female XLR (pin 2 hot), and barrier terminal strip Type: Electronically balanced/unbalanced, RF filtered Impedance: Balanced 40kΩ, unbalanced 20kΩ Max Input Level: >+21dBu balanced or unbalanced CMRR: >40dB, typically >55dB at 1kHz Outputs Connectors: 1/4" TRS, male XLR (pin 2 hot), and barrier terminal strip Type: Impedance-balanced/unbalanced, RF filtered Impedance: Balanced 200Ω, unbalanced 100Ω Max Output Level: >+21dBu balanced/unbalanced into 2kΩ or greater >+18dBm balanced/unbalanced (into 600Ω)</p>	

BIL	PERALATAN	SPESIFIKASI	GAMBAR
17.	<p>LCD Projector</p> <p>Model PANASONIC</p> <p>Brand PT-LB1VEA</p>	<p>Panasonic Multimedia Projector PT-LB 1 VEA XGA (1024X768) (2200 ANSI Lumens) Compact Mobile Projector with One-Touch Auto Everything Set-Up Auto Power off Daylight View Technology Wired LAN Lamp Life 5000 hours'</p>	
18	<p>Microphone Case</p> <p>Model GATOR</p> <p>Brand GM-6-PE</p>	<p># of Mics Stored 6 Additional Internal Storage No Additional Storage Case Type Hard Ext Construction/Materials Lightweight Polyethylene Handle/Straps Handle Pockets No Pockets Weight 4 lbs. Manufacturer Part Number GM-6-PE</p>	

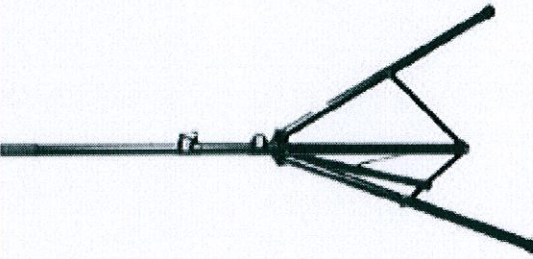
BIL	PERALATAN	SPESIFIKASI	GAMBAR
19	<p>DVD Player</p> <p>Model PIONEER</p> <p>Brand DV 2012</p>	<p>Manufacturer Part Number GM-6-PE" Terminals</p> <ul style="list-style-type: none"> -USB (CD -> USB Recording) 1 -Component Video Output 1 -Video Output 1 -Audio Output 1 -Coaxial Digital Output 1 -Specifications -Power Requirements 110-240 V 50/60 Hz -Power Consumption 7 W -Power Consumption during Standby Mode 0.9 W -Dimensions (W x H x D) 360 x 42 x 202 mm -Weight 1.2 kg 	
20.	<p>Speaker Stand</p> <p>Model TAIWAN</p> <p>MADE</p>	<p>The steel-aluminum design on this affordable speaker stand make it both light weight and durable. Use either the 1-3/8" diameter upper shaft or the included 1-1/2" adapter sleeve for a universal fit.</p> <p>200lb (90kg) Weight Capacity</p> <p>Base Spread: 32"- 48"</p> <p>Non-slip Rubber Feet</p> <p>Black Powder Coat Finish</p> <p>Height adjustment: 44"-80"</p>	

BIL	PERALATAN	SPESIFIKASI	GAMBAR
21.	<p>Microphone Stand Model TAIWAN MADE</p>	<p>Adjustable from 9" -13" Removable shaft Round weighted 6" base Die-cast steel clutch Black Finish</p>	
22.	<p>Note Book Model HP ELITE BOOK Brand 8760W</p>	<p>Operating system - Windows® 7 Professional 32 - Windows® 7 Professional 64 - Windows® 7 Home Premium 64 - FreeDOS Processor technology - Intel® Core™ i5 and i7 with vPro technology (select models) Chipset - Mobile Intel® QM67 Express Dimensions (W x D x H) - 41.65 x 27.27 x 3.74 cm Weight - Starting at 3.47 kg (Starting weight is with SSD and weight saver) Internal drive - SATA II (7200 rpm)</p>	

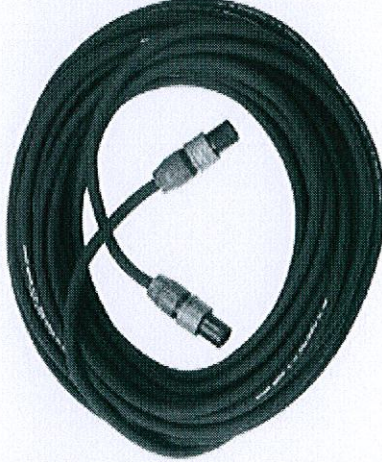
BIL	PERALATAN	SPESIFIKASI	GAMBAR
		<p>From: 320 GB Up to: 750 GB SED SATA II (7200 rpm) Up to: 320 GB Solid State Drive From: 128 GB Up to: 256 GB Optical drive Blu-ray R/RE DVD+/-RW SuperMulti DL Blu-ray ROM DVD+/-RW SuperMulti DL DVD+/-RW SuperMulti DL DVD-ROM</p>	
23.	<p>Speaker Cable 2 Core Model LOCAL Brand FAJAR</p>	<p>16 AWG 2 CORE</p>	

BIL	PERALATAN	SPESIFIKASI	GAMBAR
24	<p>Microphone Stand</p> <p>Model KONIG&MEYER</p>	<p>Mic Stand: Height: from 625 to 1,480 mm Height adjustment: non-scratching locking screws Leg construction: socket with foldable legs Material: steel Product Category: Baseline Rod combination: 3-piece folding design Size when folded: 560 mm Special features: plastic base; folds very small Threaded connector: 3/8" Type: black Weight: 1.52 kg Boom arm: 2-piece telescopic design Boom arm length: from 425 to 725 mm Clamping: wing nut Material: steel Threaded connector: 3/8" Type: black Weight: 0.58 kg</p>	